

SHEAVE/PULLEY ALIGNMENT

Quick and easy with "visual" reading

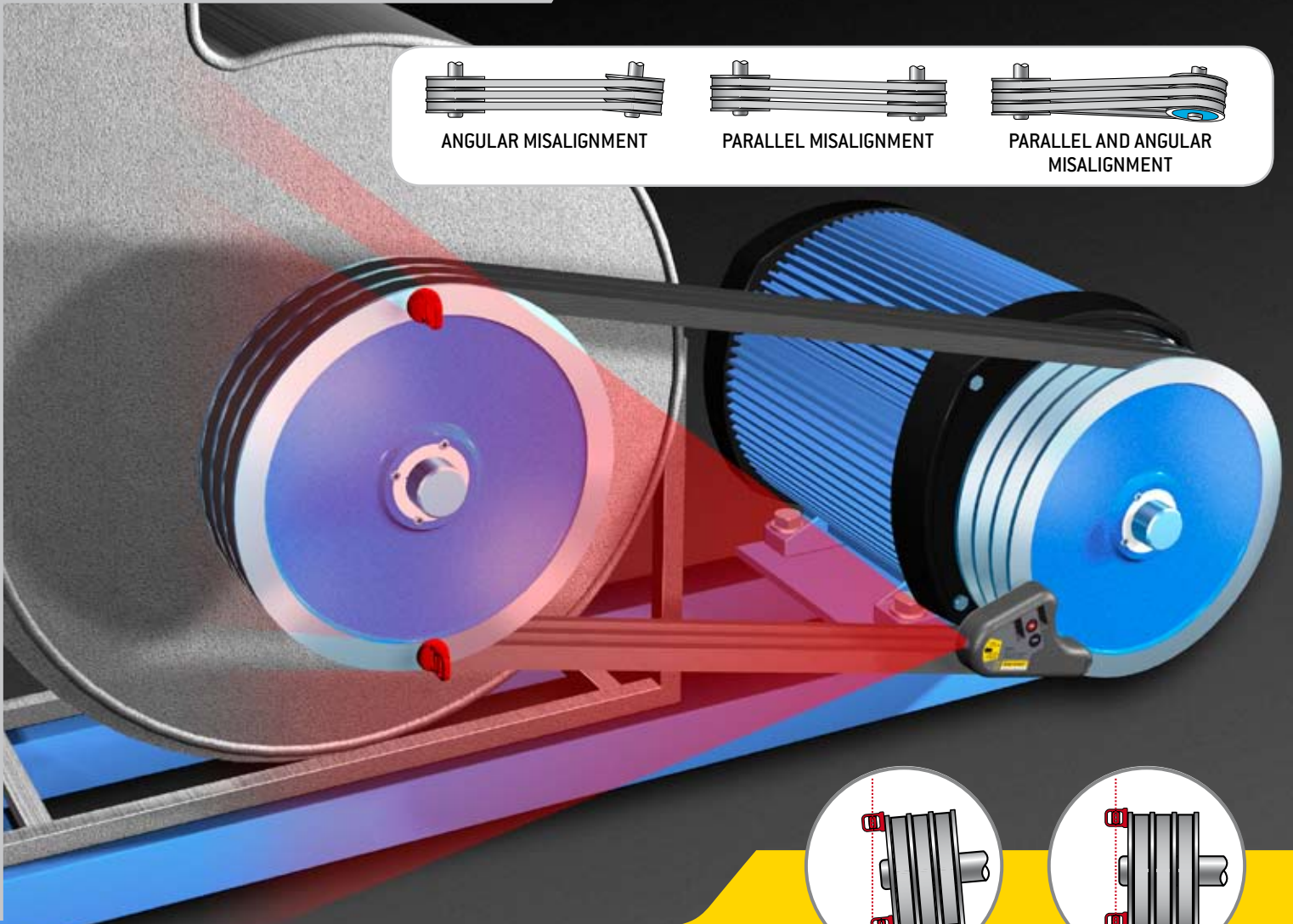

ANGULAR MISALIGNMENT

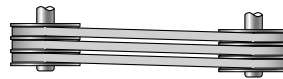

PARALLEL MISALIGNMENT



PARALLEL AND ANGULAR MISALIGNMENT

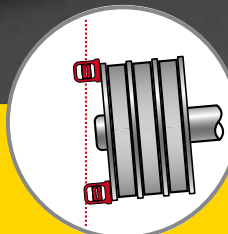

MISALIGNED

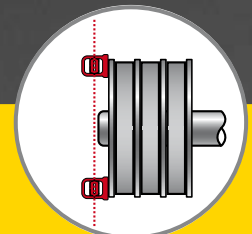

ALIGNED

- Shows the parallel and angular misalignment between the sheaves.
- Much faster and more accurate than measuring with earlier, conventional methods.
- For both horizontal and vertical mounted machines.
- Alignment can be made by one operator.
- Also suitable for non-magnetic sheaves.
- Fits almost any kind of sheave:

Easy-Laser® BTA is the perfect tool for sheave and pulley alignment. Mounted in a few seconds, the laser line projected onto the targets allows you to quickly ascertain and correct the misalignment. It couldn't be easier!



V-BELTS



FLAT BELTS



TIMING BELTS



CHAIN DRIVES



EASY FOR THE USER

The tool is attached in a few seconds, and you can easily see the laser line projected on the targets. When the line lies in the slots of the targets, the machine is in the right position. The result is a fast, precise alignment.

(Example of pulley alignment.)

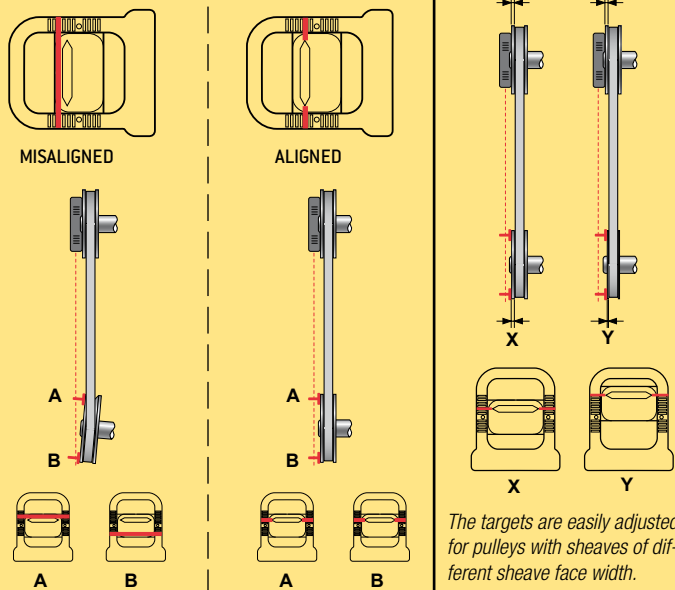

The targets are easily adjusted for pulleys with sheaves of different sheave face width.

LARGE COST SAVINGS

Transmissions with two or more belts, or wide belts, are highly affected by misalignment, causing large differences in belt tensions and also increased wear and tear on edges. When aligning with the Easy-Laser® BTA you reduce the wear on sheaves/pulleys, belts, bearings and seals as well as reducing vibration. Increased efficiency also means large energy cost savings.

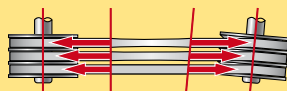

TECHNICAL SPECIFICATIONS Complete tool: Part.Nr. 12-0415

Laser transmitter

Sheave diameters	Ø 2.5" [60 mm] and larger
Sheave thickness	Not depending on sheave thickness
Beam angle	60°
Measurement distance	33 feet [10 m]
Battery type	1 x R6 (AA) 1.5 V
Battery operation	>8 hours continuously
Laser class	2
Output power	<1 mW
Laser wavelength	635-670 nm
Housing material	ABS plastics/Hard anodized aluminum
Dimensions	WxHxD: 5.8"x3.4"x1.1" [145x86x30 mm]
Weight	8.6 oz [0.27 kg]

Targets 2 pcs. magnet targets

Feature Because of its light weight it can be mounted on non-magnetic sheaves with double sided adhesive tape.

Calibration The laserline generated by the tool is calibrated parallel to the reference surface. Accuracy: Offset < 0.008" [0.2 mm], Parallelity < 0.05°

Easy-Laser® is manufactured by Damalini AB, Åbäcksgatan 6B, 431 67 Mölndal, Sweden, Phone +46 31 708 63 00, Fax +46 31 708 63 50, email: info@damalini.se, www.damalini.com © 2007 Damalini AB. We reserve the right to make modifications without prior notification. Easy-Laser® is a registered trademark of Damalini AB.

www.easylaserusa.com

FOR ALL TYPES OF SHEAVE/PULLEY

Easy-Laser® D90 BTA is attached to the side of the sheave/pulley and not to the belt groove. This means it is just as easy to adjust v-belt, flat belt and timing belt pulleys as chain wheels. The clever design of the anchor plate/reference surface ensures hassle-free alignment of both large and small sheaves/pulleys.

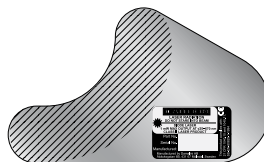

Magnetic reference surface on both transmitter and targets for easy attachment to the sheaves.

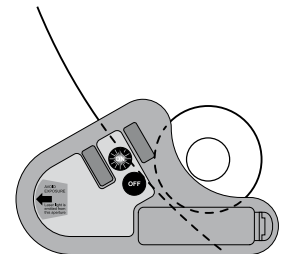

Easy-Laser® D90 fits small as well as large sheaves.

ADD A DIGITAL DISPLAY UNIT

Easy-Laser® D90 BTA has targets that are read "visually" and ensure excellent accuracy. That is enough for many users. If, in the future, you want to have a digital display and its associated benefits, you can purchase one of our detector units (shown below), which can detect the laser line from Easy-Laser® D90 BTA. Full expandability in true Easy-Laser® fashion!



Detector unit 12-0308

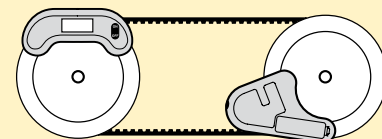

Detector unit 12-0403
Display unit 12-0404
Cable 12-0074

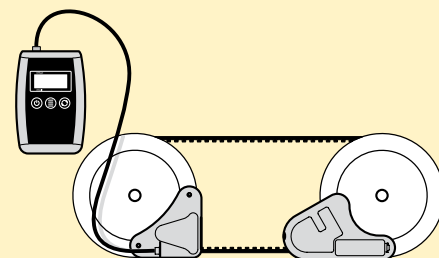

Small, padded transportation bag fits easily in any tool case.



Belt clip on back side.

Authorized dealer